

OMS

ENG INSTRUCTIONS FOR USE.



Set OMS REF 1700769-001



REF 1601102-001 REF 1303393-001 REF 1600755-001 REF 1601069-001 REF 1600631-001 REF 1500984-005 REF 1307727-010 REF 1301575-001 REF 1502329-002

Options

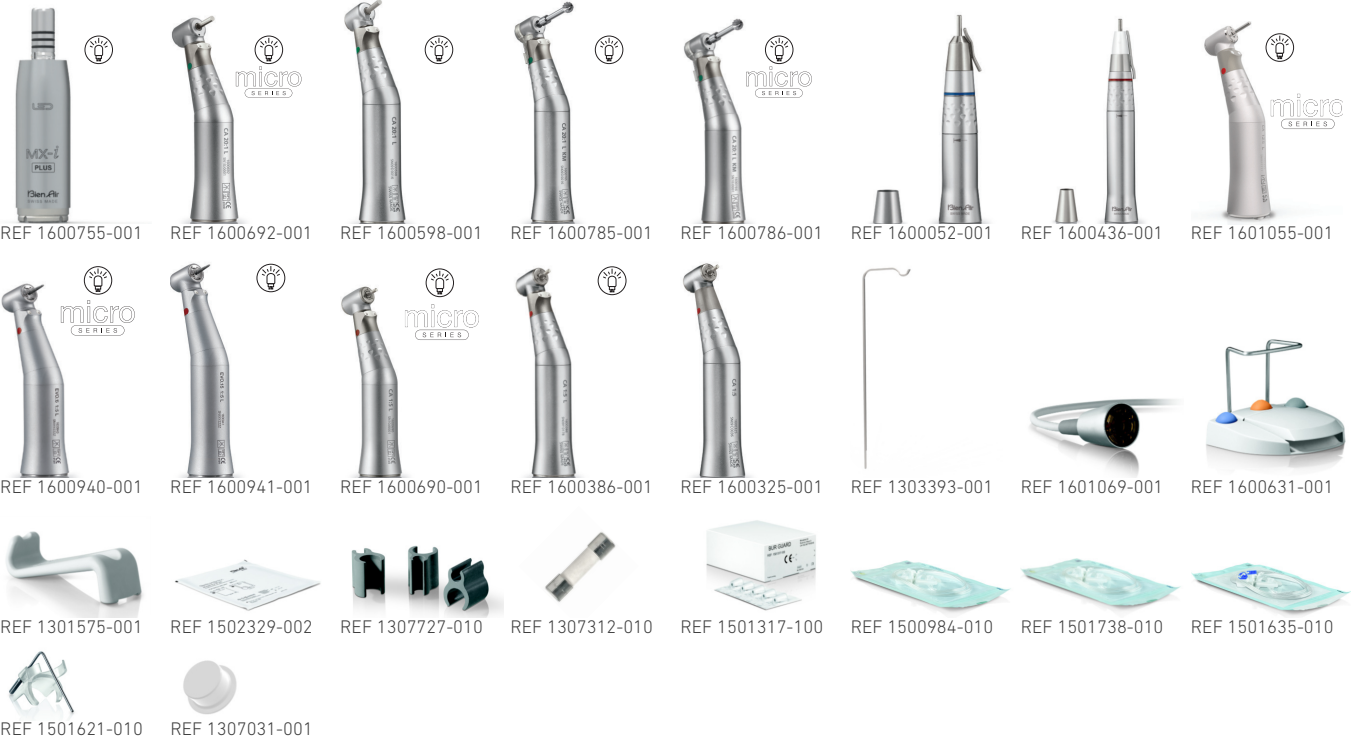

REF 1600755-001 REF 1600692-001 REF 1600598-001 REF 1600785-001 REF 1600786-001 REF 1600052-001 REF 1600436-001 REF 1601055-001

REF 1600940-001 REF 1600941-001 REF 1600690-001 REF 1600386-001 REF 1600325-001 REF 1303393-001 REF 1601069-001 REF 1600631-001

REF 1301575-001 REF 1502329-002 REF 1307727-010 REF 1307312-010 REF 1501317-100 REF 1500984-010 REF 1501738-010 REF 1501635-010

















REF 1501621-010 REF 1307031-001

Table of contents













1	Symbols.....	2
1.1	Description of symbols for OMS units	2
1.2	Description of symbols for OMS accessories	2
2	Identification, Intended Use and Notation... 3	
2.1	Identification	3
2.2	Intended use	3
2.3	Notation and chapter links	3
3	Warnings & Precautions of Use	4
4	Description.....	5
4.1	OMS system overview	5
4.2	Sets supplied.....	6
4.3	Options	6
4.4	Technical data	7
4.5	Environmental protection and information for disposal.....	7
4.6	Electromagnetic compatibility (technical description)	8
4.6.1	Precautions of use	8
4.6.2	Electromagnetic compatibility.....	8
4.6.3	Electromagnetic compatibility – emissions & immunity	8
5	Installation	10
5.1	Install the OMS system.....	11
5.2	On/off procedure.....	11
6	Interface overview.....	12
6.1	OMS modes.....	12
6.2	Rotating knob functions overview.....	12
6.3	Sound alerts	13
7	Operation - Implantology mode	14
7.1	Operation screen description	14
7.2	Perform an operation, steps P1 and P2.....	14
7.3	Perform an operation, steps P3, P4 and P5.....	14
8	Operation - Surgery mode	16
8.1	Operation screen description	16
8.2	Perform an operation	16
9	Settings	18
9.1	Operation mode	18
9.2	MX-i LED micromotor speed.....	18
9.3	MX-i LED micromotor torque.....	18
9.4	MX-i LED micromotor rotation direction	18
9.5	Irrigation level.....	19
9.6	Contra-angle ratio.....	19
9.7	Luminosity level	19
10	Special modes.....	20
11	List of errors & Troubleshooting	22
11.1	Safety warning (operating).....	22
11.2	Device operating error.....	23
12	Maintenance	24
12.1	Servicing.....	24
12.2	Cleaning & disinfection.....	24
12.3	Important.....	24
12.4	Replacement of fuses.....	25
13	General information and guarantee.....	26
13.1	General information	26
13.2	Terms of guarantee	26

1 Symbols

1.1 Description of symbols for OMS units

Symbol	Description	Symbol	Description
	CE Marking with number of the notified body.		Recyclable materials.
	Main switch - Power OFF.		Separate collection of electric and electronic equipment.
	Main switch - Power ON.		Manufacturer.
	Fuse Ø 5 x 20 mm.		Light.
	Alternating current.		Sound alerts.
	RF emitting device (Interference may occur in the vicinity of equipment marked with this symbol).		Warning: in accordance with federal law (USA), this device is only available for sale upon recommendation by an accredited practitioner.
	CAUTION! Consult accompanying documents. Provides an instruction that should be observed for safety reasons.		CSA marking - Complies with U.S. and Canadian standards.
	Refer to the accompanying documents (www.bienair.com/ifu).		Serial number.
	Reference number.		

1.2 Description of symbols for OMS accessories

Symbol	Description	Symbol	Description
	CE Marking with number of the notified body.		Machine washable.
	Expiration date.		Recyclable materials.
	Do not reuse.		Separate collection of electric and electronic equipment.
	Sterilized with Ethylene Oxide.		Sterilizable in autoclave up to the specified temperature.
	Electrical safety. Applied part type B.		Manufacturer.
	Reference number.		Serial number.

2 Identification, Intended Use and Notation

2.1 Identification

Electronically controlled tabletop device for dentistry allowing operation of a dental handpiece via an MX-i LED micromotor with variable speed control by a pedal.

A peristaltic pump conveys the physiological liquid via a disposable irrigation line without being contaminated.

The device's LCD display indicates and allows to control operation settings.

2.2 Intended use

The equipment is meant to be used by dentists and surgeons in dental offices and hospitals. OMS dental unit is intended to control a dental micromotor for oral surgery and implantology. Any use other than what is specified herein is unauthorized and may be dangerous. The system meets all the current legal requirements for medical devices.

The intended electromagnetic environment (per IEC 60601-1-2 ed. 4.0) is Professional healthcare facility environment.

2.3 Notation and chapter links

- **A, B, C**, etc.
Text preceded by a letter indicates a procedure to be carried out step-by-step.
- 
Indicates a procedure result.
- **(1), (2), (3)**, etc.
Text preceded by a number indicates text used in conjunction with an illustration.
- ***OK, Settings***, etc.
Text in bold italic font style indicates, on-screen elements such as buttons, menus, menu items, screen areas, values, fields when they are named and screen names.

In order to simplify the notation, in this manual:

- «Clockwise» is referred to as «CW»;
- «Counterclockwise» is referred to as «CCW»;
- Forward micromotor rotation mode is referred to as «FWD»;
- Reverse micromotor rotation mode is referred to as «REV»;
- Rotational speed unit «revolutions per minute» is referred to as «rpm»;
- Torque unit «newton centimetre» is referred to as «Ncm»;
- Micromotor control unit is referred to as «DMX»;
- Implantology and Surgery are referred to as «IM» and «SR».

3 Warnings & Precautions of Use

⚠ CAUTION

The power plug is used for disconnection in case of problems, it must be easily accessible at all times.

⚠ CAUTION

Never connect a handpiece on a running MX-i LED micromotor.

⚠ CAUTION

Any modification of the medical device is strictly forbidden.

⚠ WARNING

The device is not designed for use in an explosive atmosphere (anaesthetic gas).

⚠ WARNING

Do not attempt to open the device when it is connected to the electric mains.
Risk of electrocution.

⚠ CAUTION

The parameters contained in the dental procedures are indicative only. Bien-Air Dental SA cannot be held liable for them.

⚠ CAUTION

The device must not be touched by the patient.

⚠ CAUTION

Do not simultaneously touch the patient and the pump or contacts of connectors.

⚠ CAUTION

Ensure that there is no water under the unit before switching it on.

⚠ CAUTION

All connectors must be dry before use. Ensure the absence of residual moisture due to cleaning.

⚠ WARNING

To avoid the risk of electric shock, this equipment must only be connected to a supply mains with protective earth.

4 Description

4.1 OMS system overview

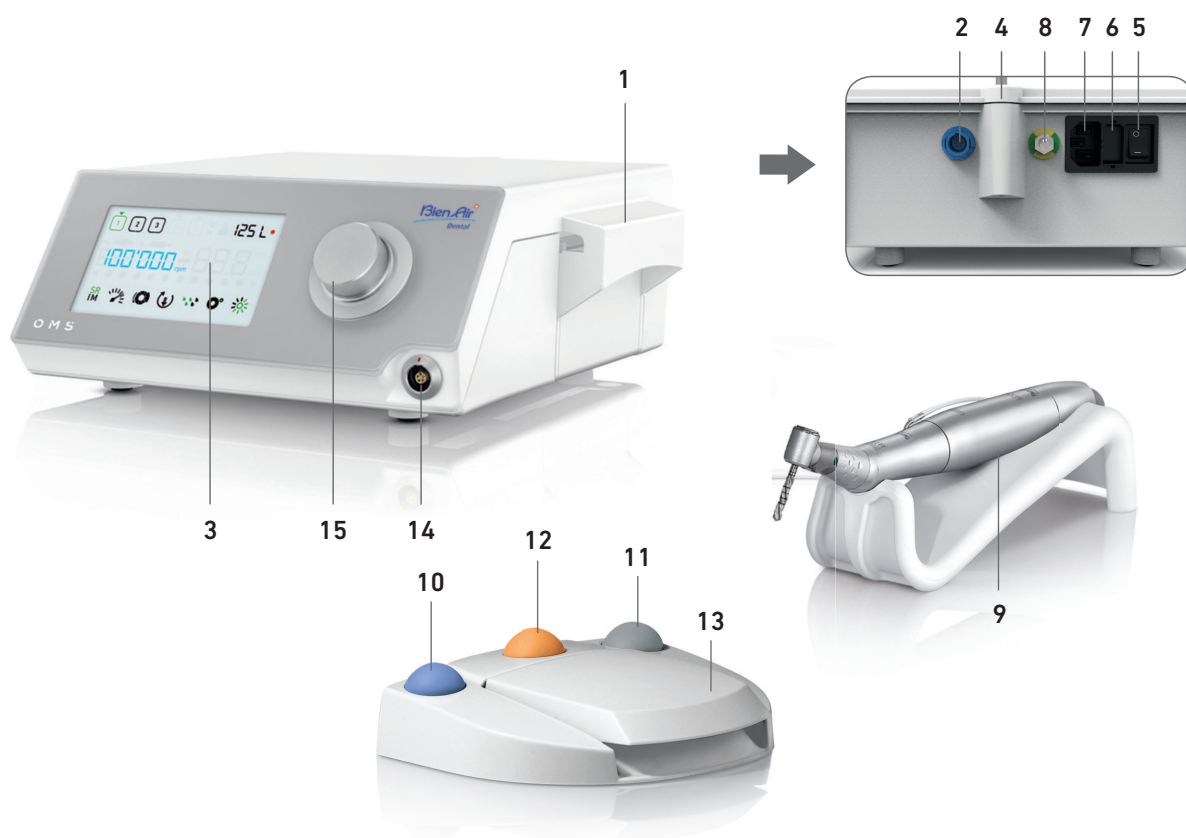

FIG. 1

- | | |
|--------------------------------------|--|
| (1) Peristaltic pump lid | (10) Button to start/stop irrigation |
| (2) Pedal connector | (11) Foot control to reverse the rotation of the MX-i LED micromotor |
| (3) LCD control screen | (12) "Program" button to go to next operation step |
| (4) Bracket support | (13) Motor start |
| (5) Main switch | (14) MX-i LED micromotor connector |
| (6) Fuse box | (15) Control knob |
| (7) Mains connector | |
| (8) Potential equalization connector | |
| (9) MX-i LED micromotor | |

4.2 Sets supplied

OMS set REF 1700769-001

Designation	REF number
OMS unit (1x)	1601102-001
MX-i LED micromotor (1x)	1600755-001
3-button pedal (1x)	1600631-001
Cable MX-i LED (2m) (1x)	1601069-001
Sterile protective sheet (2x)	1502329-002
Pack of 5 disposable sterile irrigation lines	1500984-005
Pack of 10 attachment collars for fastening the sterile irrigation line to a cable	1307727-010
Bracket for fluid bottle (1x)	1303393-001
Handpiece support (1x)	1301575-001
3P cable system, US, medical grade, length 3m (1x)	1307572-001

4.3 Options

Designation	REF number
3-button pedal	1600631-001
MX-i LED micromotor	1600755-001
Contra-angle handpiece CA 20:1 L KM Micro-Series (light)	1600786-001
Contra-angle handpiece CA 20:1 L KM (light)	1600785-001
Contra-angle handpiece CA 20:1 L Micro-Series (light)	1600692-001
Contra-angle handpiece CA 20:1 L (light)	1600598-001
Contra-angle handpiece EVO.15 1:5 L Micro-Series (light)	1600940-001
Contra-angle handpiece EVO.15 1:5 L (light)	1600941-001
Contra-angle handpiece CA 1:5 L Micro-Series (light)	1600690-001
Contra-angle handpiece CA 1:5 L (light)	1600386-001
Contra-angle handpiece CA 1:5	1600325-001
Contra-angle handpiece CA 1:2.5 L Micro-Series (light)	1601055-001
Straight handpiece PM 1:1	1600052-001
Straight handpiece PM 1:2	1600436-001
Sterile protective sheet (2x)	1502329-002
Box of 100 sterile Bur Guards	1501317-100
Pack of 10 disposable sterile lines 3.5 m	1501738-010
Kirschner/Meyer pack of 10 disposable sterile lines	1501635-010
Kirschner/Meyer type detachable irrigation set for CA 20:1 L KM and CA 20:1 L KM Micro-Series, comprising 10 rings and 10 tubes	1501621-010
Pack of 10 disposable sterile lines	1500984-010
Bracket for fluid bottle	1303393-001
Handpiece support	1301575-001
Cable MX-i LED (2m)	1601069-001
3P cable system, US, medical grade, length 3m (1x)	1307572-001
Pack of 10 attachments collars for fastening the sterile irrigation line to a cable	1307727-010
Pack of 10 fuses T4.0AH 250 VAC high breaking capacity	1307312-010
Knob	1307031-001

4.4 Technical data

Dimensions L x W x H

OMS unit.....	240 x 240 x 102 mm
OMS unit (with bracket).....	240 x 240 x 482 mm
Pedal.....	200 x 180 x 54 mm
Pedal (with handle).....	200 x 180 x 144 mm
Motor cable (REF 1601069).....	L 2.0 m
Pedal cable.....	L 2.9 m
MX-i LED micromotor.....	23 x 91 mm

The pedal is waterproof (IP X8 in accordance with IEC 60529).

Weight

OMS unit.....	2.2 kg
Pedal.....	830 g
Bracket.....	115 g
Cable.....	105 g
MX-i LED micromotor.....	115 g

Electrical data

Voltage.....	100 – 240 VAC
Frequency.....	50-60 Hz

Operating parameters

Adjustable speed range.....	100 - 40.000 rpm
Max. torque.....	80 Ncm

Environmental conditions

Environmental conditions	Operating	Transport and storage (max. 15 weeks)
Temperature	+5°C (41°F) to +35°C (95°F)	-25°C (-13°F) to +70°C (158°F)
Relative humidity (including condensation)	30% to 80%	10% to 100%
Atmospheric pressure	700 hPa to 1060 hPa	500 hPa to 1060 hPa

⚠ CAUTION

Do not use OMS outside the range of operating temperature.

Classification

Class IIa in accordance with European Directive 93/42/EEC concerning medical devices.

Electric insulation class

Class I per IEC 60601-1 (apparatus protected against electric shocks).

⚠ CAUTION

The device must be only used by the operator.

Applied parts (per IEC 60601-1):

MX-i LED micromotor.....	REF 1600755-001
CA 20:1 L.....	REF 1600598-001
CA 20:1 L Micro-Series.....	REF 1600692-001
CA 20:1 L KM.....	REF 1600785-001
CA 20:1 L KM Micro-Series.....	REF 1600786-001
CA EVO.15 1:5 L Micro-Series.....	REF 1600940-001
CA EVO.15 1:5 L.....	REF 1600941-001
CA 1:5 L Micro-Series.....	REF 1600690-001
CA 1:5 L.....	REF 1600386-001
CA 1:5.....	REF 1600325-001
CA 1:2.5 L Micro-Series.....	REF 1601055-001
PM 1:1.....	REF 1600052-001
PM 1:2.....	REF 1600436-001
Irrigation lines.....	REF 1500984-010
KM Irrigation lines.....	REF 1501635-010

Degree of ingress protection

IP 41 (protection against insertion of objects larger than 1 mm and dripping water (vertically falling drops)).

Memory

Memory storage of 5 steps settings including adjustment of mode, speed, torque, rotation direction, irrigation, contra-angle ratio and light intensity for each step.

Languages

English.

Bracket for physiological liquid flask

Stainless steel.

Peristaltic pump

Pump delivery.....From 30 to 150 ml/min.
(5 levels)

Hose for pump.....External Ø 5.60 mm
.....Internal Ø 2.40 mm

Wall thickness.....1.60 mm

Intended for use with: See instructions for use

MX-i LED micromotor.....REF 2100245

Cable MX-i LED.....REF 2100163

Contra-angle CA 20:1 L, light.....REF 2100209

Contra-angle CA 20:1 L

Micro-Series, light.....REF 2100209

Contra-angle CA 20:1 L KM, light.....REF 2100209

Contra-angle CA 20:1 L KM

Micro-Series, light.....REF 2100209

Contra-angle handpiece EVO.15 1:5 L

Micro-Series, light.....REF 2100294

Contra-angle handpiece EVO.15 1:5 L,

light.....REF 2100294

Contra-angle handpiece CA 1:5 L

Micro-Series, light.....REF 2100294

Contra-angle handpiece CA 1:5 L,

light.....REF 2100294

Contra-angle handpiece CA 1:5.....REF 2100294

Contra-angle handpiece CA 1:2.5 L

Micro-Series, light.....REF 2100337

Straight Handpiece PM 1:1.....REF 2100046

Straight Handpiece PM 1:2.....REF 2100103

⚠ CAUTION

The use of the system with other handpieces, motors or cables has not been validated/certified (speed and torque values are not guaranteed in this case).

List of errors & Troubleshooting

See chapter "11 List of errors & Troubleshooting" on page 22.

4.5 Environmental protection and information for disposal



The disposal and/or recycling of materials must be performed in accordance with the legislation in force.



Separate collection of electric and electronic equipment and accessories in view of recycling.

Electrical and electronic equipment may contain dangerous substances which constitute health and environmental hazards. The user must return the device to its dealer or establish direct contact with an approved body for treatment and recovery of this type of equipment (European Directive 2002/96/EC).

4.6 Electromagnetic compatibility (technical description)

4.6.1 Precautions of use

This electronic control is in compliance with electrical safety standards in line with standard IEC 60601-1, edition 3.1, and those governing electromagnetic compatibility in line with standard IEC 60601-1-2, fourth edition.

⚠ CAUTION

The device must be used by a competent person, in particular in compliance with the legal provisions in force regarding occupational safety, health and accident prevention measures, and the current instruction for use. According to these measures, the user has the following obligations:

- to only use devices that are in perfect working order
- to make sure that the device is used solely for the purpose for which it is intended
- avoid contact with liquids.

4.6.2 Electromagnetic compatibility

⚠ CAUTION

The OMS complies with the EMC requirements according to IEC 60601-1-2. Radio transmitting equipment, cellular phones, etc., should not be used in the immediate vicinity of the device, since this could affect its operation. The device is not suitable for being used close to high-frequency surgical equipment, magnetic resonance imaging (MRI) and other similar devices where the intensity of electromagnetic disturbances is high. In any case, ensure that no high frequency cables are routed above or near the device. If in doubt, contact a qualified technician or Bien-Air Dental SA.

Portable RF communications equipment (including peripherals such as antenna cables and external antennas) should be used no closer than 30 cm (12 inches) to any part of the OMS, including cables specified by the manufacturer. Otherwise, degradation of the performance of this equipment could result.

⚠ CAUTION

The use of accessories, transducers and cables other than those specified, with the exception of transducers and cables sold by Bien-Air Dental SA as spare parts for internal components, may result in increased emissions or decreased immunity.

4.6.3 Electromagnetic compatibility – emissions & immunity

Guidance and manufacturer’s declaration – Electromagnetic emissions

The OMS is intended for use in the electromagnetic environment specified below. The customer or the user of the OMS must ensure that it is actually used in such an environment.

Emissions test	Compliance	Electromagnetic environment - guidance
RF emissions CISPR 11	Group 1	The OMS is suitable for use in any building, including residential buildings and those directly connected to the public low-voltage power supply network that supplies buildings used for residential purposes.
RF emissions CISPR 11	Class B	
Harmonic emissions IEC 61000-3-2	Class A	
Emissions due to voltage fluctuations IEC 61000-3-3	Conforming	

Guidance and manufacturer’s declaration – Electromagnetic immunity

The OMS is intended for use in the electromagnetic environment specified below. The customer or the user of the OMS must ensure that it is actually used in such an environment.

Immunity test	IEC 60601 test level	Compliance level	Electromagnetic environment - guidance
Electrostatic discharge (ESD) IEC 61000-4-2	±8 kV contact ±2 kV air ±4 kV air ±8 kV air ±15 kV air	±8 kV contact ±2 kV air ±4 kV air ±8 kV air ±15 kV air	Floors should be wood, concrete or ceramic tile. If floors are covered with synthetic material, the relative humidity should be at least 30%.
Electrical fast transient/burst IEC 61000-4-4	±2 kV for power supply lines ±1 kV for other lines	±2 kV for power supply lines N.A.	Mains power quality should be that of a commercial or hospital environment.

Immunity test	IEC 60601 test level	Compliance level	Electromagnetic environment - guidance	
Surge IEC 61000-4-5	±0.5 kV line to line ±1 kV line to line ±0.5 kV line to earth ±1 kV line to earth ±2 kV line to earth	±0.5 kV line to line ±1 kV line to line ±0.5 kV line to earth ±1 kV line to earth ±2 kV line to earth	Mains power quality should be that of a commercial or hospital environment.	
Voltage dips, short interruptions and voltage variations on power supply input lines IEC 61000-4-11	0% U_T for 0.5 cycle, at 0°, 45°, 90°, 135°, 180°, 225°, 270° and 315° 0% U_T for 1 cycle and 70% U_T for 25/30 cycles at 0° 0% U_T for 250 cycles at 0°	0% U_T for 0.5 cycle, at 0°, 45°, 90°, 135°, 180°, 225°, 270° and 315° 0% U_T for 1 cycle and 70% U_T for 25/30 cycles at 0° 0% U_T for 250 cycles at 0°	Mains power quality should be that of a commercial or hospital environment. If the user of the OMS requires continued operation during mains power interruptions, it is recommended that the OMS be powered from an uninterruptible power supply or a battery.	
Magnetic field due to mains frequency (50/60 Hz) IEC 61000-4-8	30 A/m	30 A/m	Magnetic fields generated by the mains frequency should be at levels characteristic of a typical location in a typical commercial or hospital environment.	
Conducted disturbances induced by RF fields IEC 61000-4-6	3 V_{RMS} 0,15 MHz – 80 MHz 6 V_{RMS} in ISM bands 0,15 MHz – 80 MHz 80% AM at 1 kHz	3 V_{RMS} 0,15 MHz – 80 MHz 6 V_{RMS} in ISM bands 0,15 MHz – 80 MHz 80% AM at 1 kHz	Field strengths from fixed RF transmitters, as determined by an electromagnetic site survey ^a should be less than the compliance level in each frequency range. Interference may occur in the vicinity of equipment marked with the following symbol:	
Radiated RF EM fields IEC 61000-4-3	3 V/m 80 MHz – 2,7 GHz 80 % AM at 1 kHz	3 V/m 80 MHz – 2,7 GHz 80 % AM at 1 kHz		
Proximity fields from RF wireless communications equipment IEC 61000-4-3	Test freq. [MHz]	Max. power [W]	Immunity test level [V/m]	Distance: 0.3 m
	385	1.8	27	
	450	2	28	
	710, 745, 780	0.2	9	
	810, 870, 930	2	28	
	1720, 1845, 1970	2	28	
	2450	2	28	
5240, 5500, 5785	0.2	9		
NOTE: U_T is the AC mains voltage prior to application of the test level. Essential performance per IEC 60601-1: The essential performance is to maintain the visual luminous intensity of the LED and the motor speed. The maximum speed deviation is ±5%.				

a. Field strengths from fixed transmitters, such as base stations for radio (cellular/cordless) telephones and mobile field radios, amateur radios, AM and FM radio broadcasts and TV broadcasts cannot be predicted theoretically with accuracy. To assess the electromagnetic environment due to fixed RF transmitters, an electromagnetic site survey should be considered. If the measured field strength in the location in which the OMS is used exceeds the RF compliance level mentioned above, the OMS should be observed to verify that it is operating normally. If abnormal operation is observed, additional measures may be necessary, such as reorienting or relocating the OMS.

5 Installation

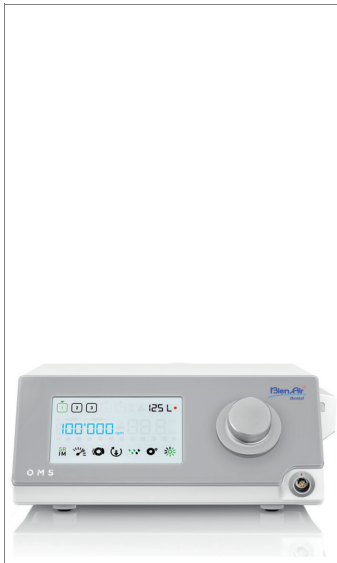

FIG. 1

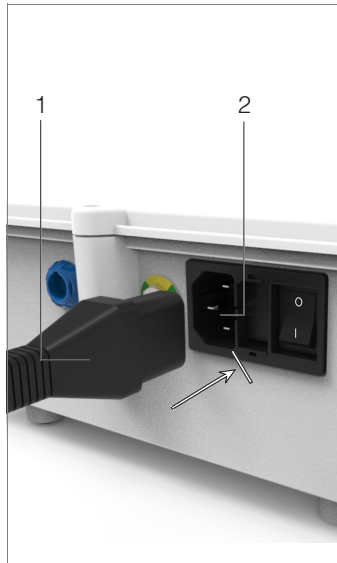

FIG. 2

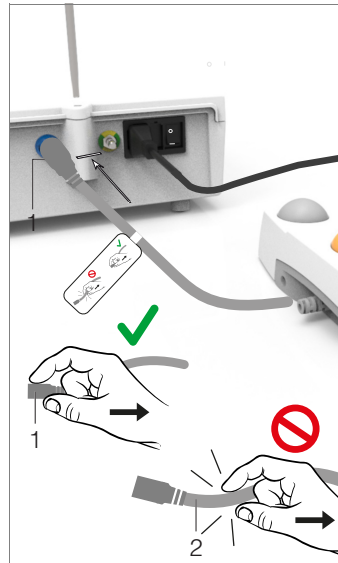

FIG. 3



FIG. 4

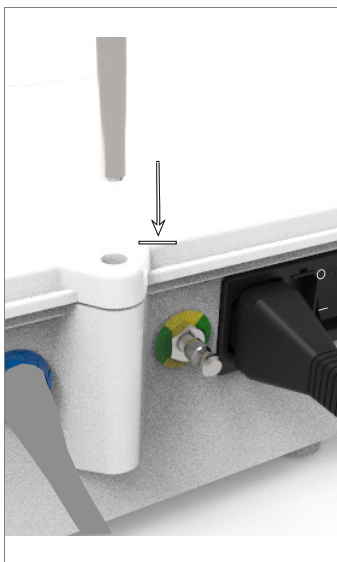

FIG. 5

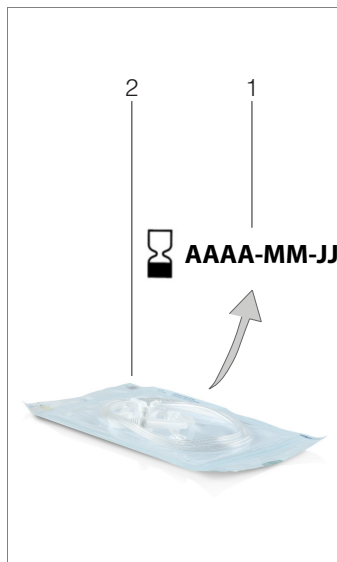

FIG. 6

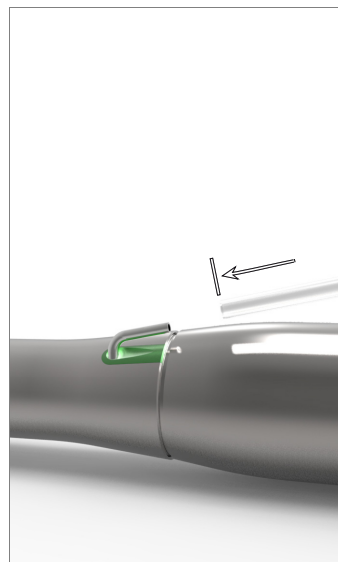

FIG. 7



FIG. 8

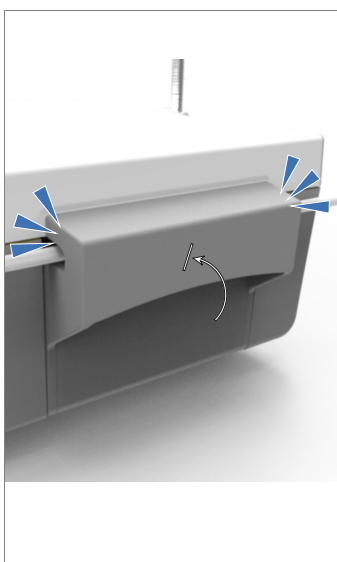

FIG. 9



FIG. 10



FIG. 11

5.1 Install the OMS system

FIG. 1

A. Place the OMS on a flat surface capable of bearing its weight.

⚠ CAUTION

It may be positioned on a table, on a trolley or any other surface but in no circumstances on the floor.

FIG. 2

B. The fuse box may be opened with a screwdriver.
100 - 240 VAC = fuse T4.0AH 250 VAC REF 1307312-010.

To replace a fuse, see chapter "12.4 Replacement of fuses" on page 25.

C. Connect the power cable (1) to the connector (2).

Note 1

⚠ CAUTION

The power plug is used for disconnection in case of problems, it must be easily accessible at all times.

FIG. 3

D. Connect the pedal cable to the input provided on the rear panel, guiding the connector and plug by means of the index pin on the connector.

⚠ CAUTION

Do not lift the pedal holding the connection cable.
To disconnect the pedal cable pull the cable socket connector (1). Do not pull the cable (2) without disconnecting the cable socket before.

FIG. 4

E. Connect the MX-i LED micromotor cable to the motor output, guiding the connector and plug by means of the index pin on the connector.

FIG. 5

F. Align and attach the bracket to the housing provided on the rear of the console and suspend the flask or bottle.

FIG. 6

G. Check the packaging integrity, as well as the expiry date of the irrigation line on the label (1).

⚠ CAUTION

The medical device must be used only with lines supplied by Bien-Air Dental to ensure trouble-free operation. These lines are sterile and for single use. Re-use may result in microbiological contamination of the patient.

H. Remove the single-use sterile irrigation line (2) from its pouch.

FIG. 7

I. Connect the flexible hose of the irrigation line to the spray tube of the handpiece or contra-angle.

FIG. 8

J. Install the peristaltic cassette (1) in the peristaltic pump (2). Check that the cassette is clipped correctly.

FIG. 9

K. Close the pump lid (3). If there is resistance to closing, open the lid again and check the correct positioning of the cassette. When the lid is correctly closed, the user should hear a click sound.

⚠ CAUTION

Do not run the pump while the lid is open.

⚠ CAUTION

Do not run the pump without irrigation line.

⚠ CAUTION

Risk of pinching!

FIG. 10

L. Perforate the cap of the physiological liquid flask with the pointed end of the irrigation line after removing the protective cap.

⚠ CAUTION

There is no detection of empty physiological liquid flask! Always check the content of the flask before operating.

FIG. 11

M. Attach the irrigation line on the motor cable using the 3 attachment collars REF 1307727-010.

5.2 On/off procedure

The device can be switched on and off in complete safety using the main switch on the OMS.

⚠ CAUTION

Do not switch off the device while the motor is running.

NOTES

1 The equipment is powered by the mains power supply (100 - 240 VAC / 300VA / 50-60Hz).

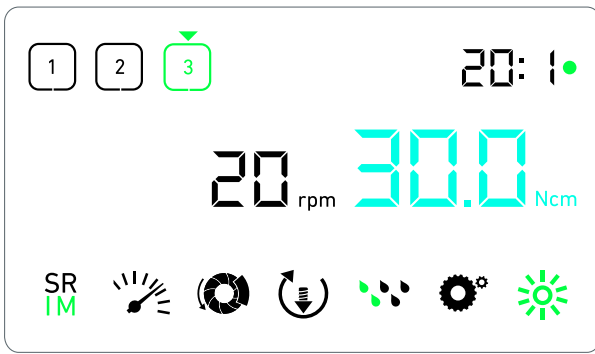

FIG. 1

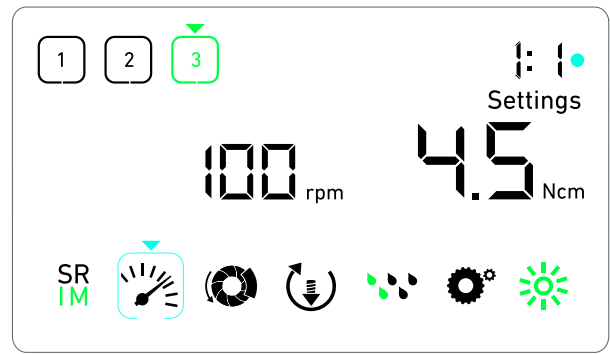

FIG. 2

6 Interface overview

6.1 OMS modes

The OMS allows to visualize and control operation parameters by the means of the LCD display.

A unique screen allows to use the following modes:

FIG. 1

- Operation mode (to perform an operation in 3 steps)

See chapter "7 Operation - Implantology mode" on page 14 for details.

FIG. 2

- Settings mode (to set up operation parameters)

See chapter "9 Settings" on page 18 for details.

FIG. 3

- Special modes (to test system and reset settings)

See chapter "10 Special modes" on page 20 for details.

FIG. 4

A. Long press on the rotating knob (1) to switch between Operation and Settings modes.

Note 1

See chapter "6.2 Rotating knob functions overview" on page 12 for details.

See chapter "10 Special modes" on page 20 for entering special modes.

6.2 Rotating knob functions overview

Note 2

Knob action	Description
CW rotation	Increase current value, go to the element on the right
CCW rotation	Decrease current value, go to the element on the left
One short press (Operation mode)	Go to the next programmed step, acknowledge error messages
One short press (Settings mode)	Enter selected setting, validate and store the current setting value, exit the current setting, acknowledge error messages
One long press	Switch between Operation and Settings modes
Double short press	Enter special modes (only when gear ratio is selected in settings mode)

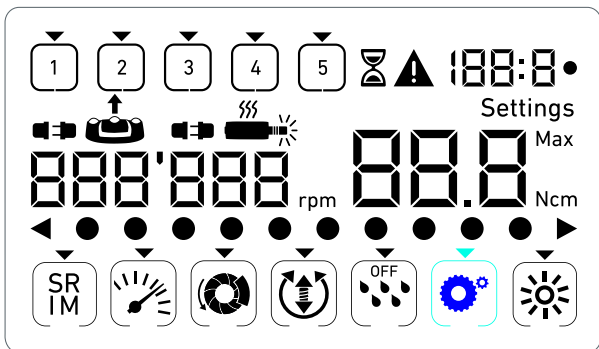

FIG. 3

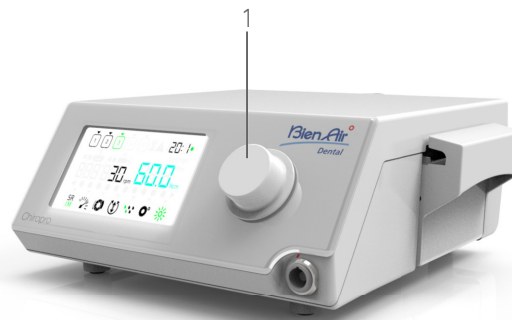

FIG. 4

6.3 Sound alerts



Sound alert	Description
One short beep	Activating irrigation, going to next step, and switching rotation direction to FORWARD
Two short beeps	Deactivating irrigation, and switching rotation direction to REVERSE
Two long beeps	Switching from low speed to high speed programmed step
Alternate short beeps	Warning notifications
Alternate medium beeps	Micromotor REVERSE running indicator
Alternate long beeps	System failure notification

NOTES

- 1 The Operation mode is the default startup mode.
- 2 Any knob or pedal action will be ignored when the motor is running.

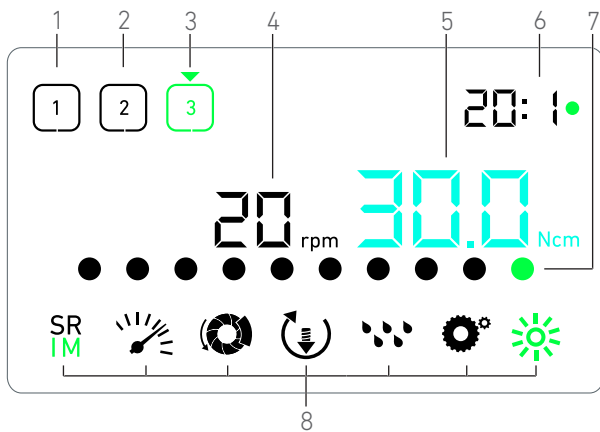

FIG. 1

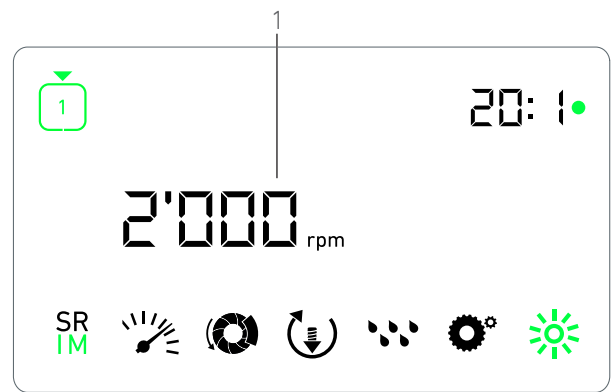

FIG. 2

7 Operation - Implantology mode

7.1 Operation screen description

FIG. 1

The Operation screen differs whether the micromotor is stopped or running and depending on the active step.

It allows to perform an operation in 3, 4 or 5 predefined steps P1, P2, P3, P4, P5 (which can respectively be used to program settings for the bone preparation, drilling, threading and implant insertion phases), and displays the following information:

- (1) Step P1 (inactive step, in black)
- (2) Step P2 (inactive step, in black)
- (3) Step P3 (active step, in green)

P4 and P5 steps are disabled by default, see "Number of steps" on page 20 for enabling them.

- (4) Speedometer

Note 1

- (5) Torquemeter

Note 2

- (6) Contra-angle ratio

Note 3

- (7) Bar graph for torque

Note 4

- (8) Operation settings symbols

See chapter "9 Settings" on page 18 for details on adjusting settings.

7.2 Perform an operation, steps P1 and P2

FIG. 2

A. Operate by pressing the footpedal to adjust the MX-i LED micromotor speed.

- ↳ Inactive steps symbols turn off when the motor is running.
- ↳ Speedometer displays real-time speed value in black.

Note 5 - 6 - 7

FIG. 3

B. If necessary, release the footpedal to perform the following actions:

- ↳ Speedometer (1) displays the set micromotor maximum reachable speed in cyan.

- Turn the knob CW or CCW to respectively increase or decrease the micromotor maximum reachable speed (quick setting mode).

Note 12

- ↳ The speedometer is cyan and displays the set micromotor maximum reachable speed (1).

Note 8

- Long press on the knob to change operation settings.

- ↳ The Settings mode is displayed.

See chapter "9 Settings" on page 18 for details.

- Long press on the orange button of the footpedal to activate the 5 Ncm torque boost.

Note 9 - 12

C. Short press on the footpedal's orange button or on the knob to go to the next step.

- ↳ The next step symbol turns green and the step's last used settings are restored.

Note 7 - 10

7.3 Perform an operation, steps P3, P4 and P5

FIG. 4

A. In steps P3 (1), P4 and P5, operate by pressing the footpedal to adjust the MX-i LED micromotor speed.

- ↳ All inactive steps symbols turn off when the motor is running.
- ↳ Speedometer (2) displays real-time value.
- ↳ Torquemeter (3) displays real-time value.
- ↳ The torque bar (5) displays ratio between the real-time torque value (represented by cyan dots when the micromotor is running) and the maximum reached torque (represented by green dot).

Note 5 - 6 - 7

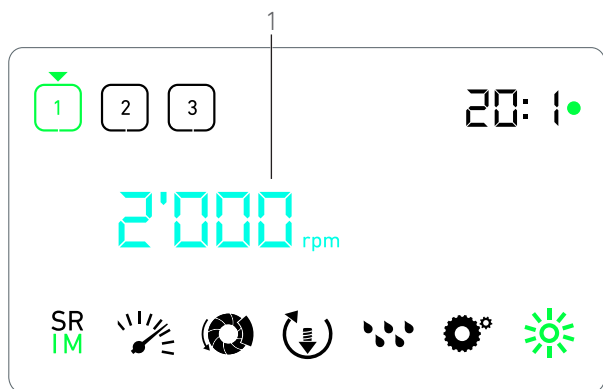

FIG. 3

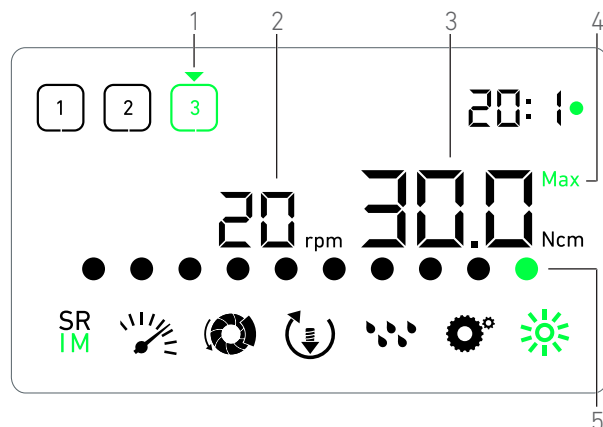

FIG. 4

B. If necessary, release the footpedal to perform the following actions:

- ↳ Torquemeter (3) displays maximum reached value together with the **Max** symbol (4).
- ↳ Torque bar (5) dots that were displayed in cyan turn black, except for the maximum value dot which turns green.
 - Turn the knob CW or CCW to respectively increase or decrease the micromotor maximum reachable torque (quick setting mode).

Note 12

- ↳ The torquemeter (3) turns cyan and displays the set micromotor maximum reachable torque.

Note 11

- Long press on the knob to change operation settings.

See chapter "9 Settings" on page 18 for details.

- Long press on the orange button to activate the 5 Ncm torque boost.

Note 9 - 12

C. Short press on the footpedal's orange button or on the knob to go to the next step.

- ↳ The next step symbol turns green and the step's last used settings are restored.

Note 7 - 10

NOTES

1 Real-time speed value is displayed in black when the MX-i LED micromotor is running. Maximum reachable speed value stored is displayed in cyan when the MX-i LED micromotor is not running, in steps P1 and P2.

2 Torquemeter is only displayed when micromotor speed is below 100 RPM in steps P1 and P2.

3 The contra-angle ratio is cyan-colored for direct-drive and green-colored for reduction gears.

4 Torque bar graph is only displayed when micromotor speed is below 100 RPM, together with the maximum torque reached during operation.

5 Each step settings are restored from the corresponding step last used settings, excluding quick settings made directly in the Operation mode.

6 In REVERSE mode, the rotation direction symbol (↺) blinks and there is a sound alert (alternate medium beeps). The torque value is automatically increased in REVERSE mode when torquemeter is displayed. The torque value can be increased from 0 to 10 Ncm, see chapter see "Reverse torque boost value" on page 20 to adjust it.

7 Actions on footpedal's buttons have no effect when the micromotor is running.

8 Changing the torque in steps P1 or P2 can only be performed through the Settings mode.

9 The torque boost can only be activated when the torquemeter is displayed in Operation mode, in low speed steps (<100 RPM).

10 For safety reasons, the speed setting icon turns red and blinks together with the speedometer for 2 seconds when switching from low speed to high speed (≥100 RPM) step.

11 Changing the speed in steps P3, P4 and P5 can only be performed through the settings mode.

12 Changes made in this mode (either by rotating the knob or by changing parameters through the footpedal buttons) are considered as temporary settings and are never saved.

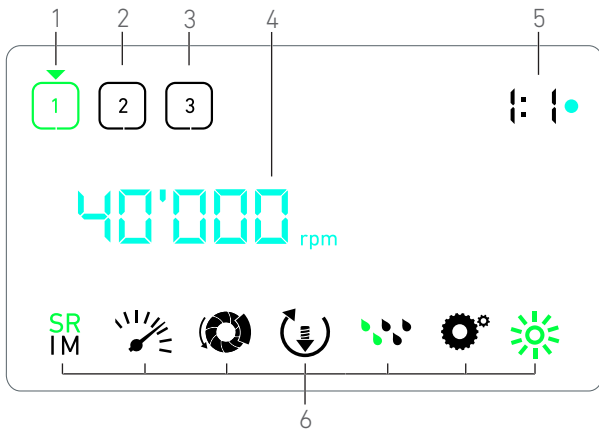

FIG. 1

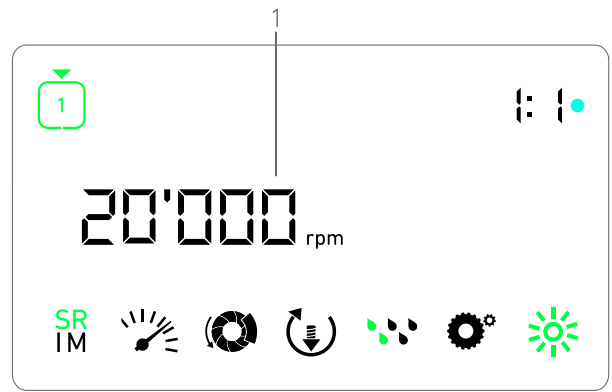

FIG. 2

8 Operation - Surgery mode

8.1 Operation screen description

FIG. 1

The Operation screen differs whether the micromotor is stopped or running and depending on the active step.

It allows to perform an operation in 3, 4 or 5 predefined steps P1, P2, P3, P4, P5, and displays the following information:

- (1) Step P1 (active step, in green)
- (2) Step P2 (inactive step, in black)
- (3) Step P3 (inactive step, in black)

P4 and P5 steps are disabled by default, see "Number of steps" on page 20 for enabling them.

- (4) Speedometer

Note 1

- (5) Contra-angle ratio

Note 2

- (6) Operation settings symbols

See chapter "9 Settings" on page 18 for details on adjusting settings.

8.2 Perform an operation

FIG. 2

A. Operate by pressing the footpedal to adjust the MX-i LED micromotor speed.

↳ Inactive steps symbols turn off when the motor is running.

↳ Speedometer displays real-time speed value in black.

Note 3 - 4 - 5

FIG. 3

B. If necessary, release the footpedal to perform the following actions:

↳ Speedometer (1) displays the set micromotor maximum reachable speed in cyan.

- Turn the knob CW or CCW to respectively increase or decrease the micromotor maximum reachable speed (quick setting mode).

Note 6

↳ The speedometer is cyan and displays the set micromotor maximum reachable speed (1).

Note 7

- Long press on the knob to change operation settings.

↳ The Settings mode is displayed.

See chapter "9 Settings" on page 18 for details.

C. Short press on the footpedal's orange button or on the knob to go to the next step.

↳ The next step symbol turns green and the step's last used settings are restored.

Note 5

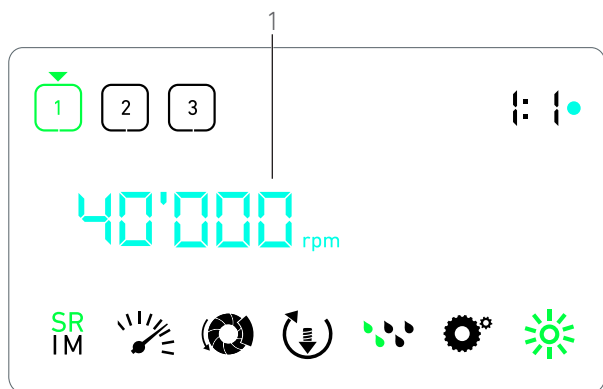



FIG. 3

NOTES

- 1 Real-time speed value is displayed in black when the MX-i LED micromotor is running. Maximum reachable speed value stored is displayed in cyan when the MX-i LED micromotor is not running, in steps P1 and P2.
- 2 The contra-angle ratio is cyan-colored for direct-drive, green-colored for reduction gears and red-colored for multiplication gears.
- 3 Each step settings are restored from the corresponding step last used settings, excluding quick settings made directly in the Operation mode.
- 4 In REVERSE mode, the rotation direction symbol  blinks and there is a sound alert (alternate medium beeps).
- 5 Actions on footpedal's buttons have no effect when the micromotor is running.
- 6 Changes made in this mode (either by rotating the knob or by changing parameters through the footpedal buttons) are considered as temporary settings and are never saved.
- 7 Changing the torque can only be performed through the Settings mode.

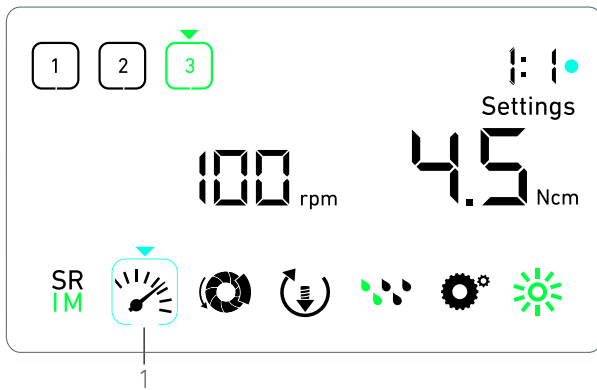

FIG. 1

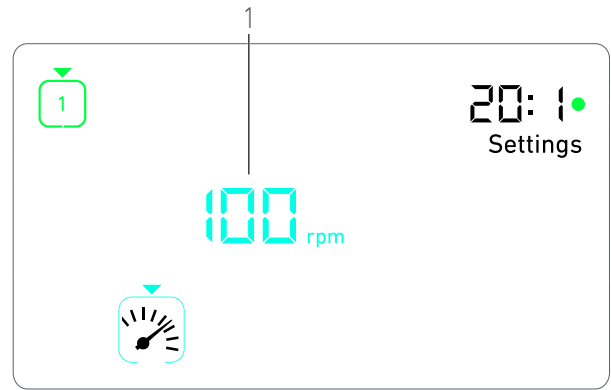

FIG. 2

9 Settings

FIG. 1

The Settings mode allows changing all parameters of each step. It is accessed by long pressing the knob from the Operation mode and leaved by also long pressing the knob or by running the motor.

Note 1

All changes made in this mode are automatically saved for the corresponding step.

Note 2

A. From the Settings mode menu, navigate through the operation parameters by turning the knob CW or CCW.

↳ The selected parameter symbol (1) is encased in a cyan square and an arrow points on it.

B. If necessary, short press on the footpedal's orange button to go to the next step without going back to the Operation mode.

↳ The Settings mode is still displayed, the next step symbol turns green and the step's last used settings are restored.

C. Short press on the knob to change the selected parameter setting (setting sub-mode).

↳ The selected setting sub-mode is displayed.

9.1 Operation mode

A. From the Settings mode menu, select the  symbol and short press on the knob to change operation mode.

Note 2

B. Turn the knob CW or CCW to alternatively toggle between IMPLANTOLOGY  and SURGERY  mode.

C. Short press on the knob to exit operation mode setting.

↳ Operation mode is saved and the Settings mode menu is displayed again, FIG. 1.

9.2 MX-i LED micromotor speed

A. From the Settings mode menu, select the  symbol and short press on the knob to change maximum reachable speed.

FIG. 2

B. Turn the knob CW or CCW to respectively increase or decrease micromotor maximum reachable speed.

↳ The speedometer (1) displays the set maximum reachable speed.

C. Short press on the knob to exit speed setting.

↳ New maximum reachable speed is saved and the Settings mode menu is displayed again, FIG. 1.

9.3 MX-i LED micromotor torque

A. From the Settings mode menu, select the  symbol and short press on the knob to change maximum reachable torque.

FIG. 3

B. Turn the knob CW or CCW to respectively increase or decrease micromotor maximum reachable torque.

↳ The torquemeter (1) displays the set maximum reachable torque.

C. Short press on the knob to exit torque setting.

↳ New maximum reachable torque is saved and the Settings mode menu is displayed again, FIG. 1.

9.4 MX-i LED micromotor rotation direction

A. From the Settings mode menu, select the  symbol and short press on the knob to change rotation direction.

Note 2

B. Turn the knob CW or CCW to alternatively toggle between FORWARD  and REVERSE  micromotor rotation.

C. Short press on the knob to exit rotation direction setting.

↳ Rotation direction is saved and the Settings mode menu is displayed again.

Note 3

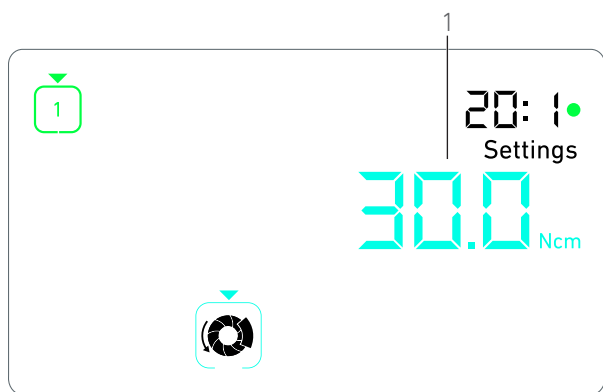

FIG. 3

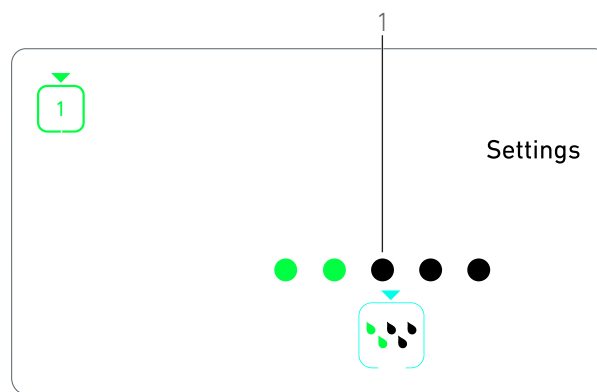



FIG. 4

9.5 Irrigation level

A. From the Settings mode menu, select the  symbol and short press on the knob to change irrigation level.

Note 2

FIG. 4

B. Turn the knob CW or CCW to set up the irrigation level (1). 6 levels of adjustment are possible: irrigation OFF, 30ml/min, 60ml/min, 90ml/min, 120ml/min, 150ml/min.

Note 4

C. Short press on the knob to exit irrigation level setting.

↳ Irrigation level is saved and the Settings mode menu is displayed again.

9.6 Contra-angle ratio

A. From the Settings mode menu, select the  symbol and short press on the knob to change the contra-angle ratio.

B. Turn the knob CW or CCW to change the contra-angle ratio.

Note 5 - 6

C. Short press on the knob to exit the contra-angle ratio setting.

↳ The contra-angle ratio is saved and the Settings mode menu is displayed again.

9.7 Luminosity level

A. From the Settings mode menu, select the  symbol and short press on the knob to change luminosity level.

Note 2

B. Turn the knob CW or CCW to set up the luminosity level. 10 levels of adjustment are possible.

C. Short press on the knob to exit luminosity level setting.

↳ Luminosity level is saved and the Settings mode menu is displayed again.

NOTES

1 Directly switching from a setting sub-mode to operation mode is not possible. The setting must be first acknowledged by means of a short press.

2 The operation mode, rotation direction, irrigation level and the luminosity level symbols differ depending on the actual settings.

3 In implantology mode, the Torque value is automatically increased in REVERSE mode when torquemeter is displayed. The torque value can be increased from 0 to 10 Ncm, see chapter "Reverse torque boost value" on page 20 to adjust it.

4 When setting the irrigation level to OFF, all dots (1) are displayed in black. Irrigation level is off when the irrigation is completely turned off by means of the footpedal's blue button, regardless of the active step. In this case, the OFF symbol is displayed in Operation mode. The irrigation is considered as a quick setting and therefore is turned ON when starting again from step P1.

5 The contra-angle ratio is cyan-colored for direct-drive, green-colored for reduction gears and red-colored for multiplication gears.

6 The contra-angle labelled "125L" corresponds to a multiplication ratio of 1:2.5.

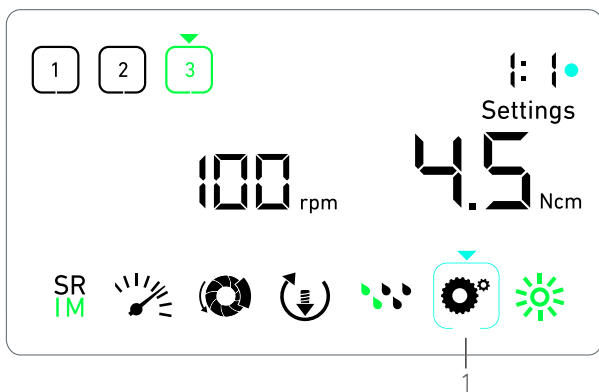

FIG. 1

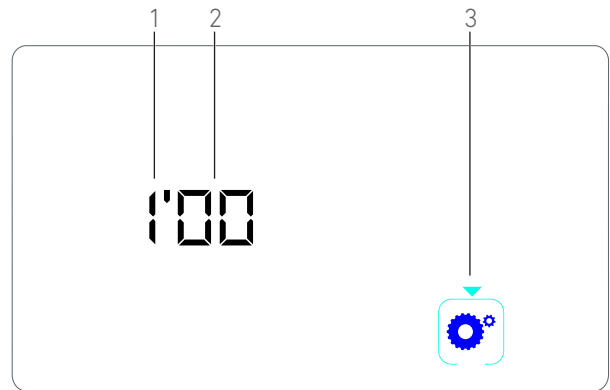

FIG. 2

10 Special modes

The special modes allow to, in the following order:

- Display software version;
- Test LCD display;
- Define number of steps (3, 4 or 5);
- Define reverse torque boost value;
- Restore factory settings.

Note 1 - 2

A. From the Operation mode, long press on the rotating knob to enter Settings modes.

↳ The Settings mode is displayed.

FIG. 1

B. Turn the knob CW or CCW to select the contra-angle ratio symbol  (1).

↳ The contra-angle ratio symbol is encased in a cyan square and an arrow points on it.

Software version

FIG. 2

C. Double short press on the knob to enter special modes.

↳ The contra-angle ratio symbol (3) turns blue to differentiate it from the ratio change cyan symbol.

↳ The software version is displayed as following:

- (1) Major version
- (2) Minor version

LCD display test

FIG. 3

D. Short press on the knob to test LCD display.

↳ All dots are displayed in black, except for the contra-angle ratio symbol (1).

Number of steps

E. Short press on the knob to define the number of steps.

↳ The step number screen is displayed.

F. Turn the knob CW or CCW to alternatively display the **3, 4** or **5** text.

G. Short press on the knob to define the number of steps.

Reverse torque boost value

Note 3

Reverse torque boost allows an automatic increase of torque value when in REVERSE mode, in order to ease bur rotation when stuck.

H. Short press on the knob to define reverse torque boost value.

↳ The reverse torque boost screen is displayed.

I. Turn the knob CW or CCW to alternatively display the **0, 5** or **10** text.

J. Short press on the knob to define no boost value when **0** is displayed, or short press on the knob to respectively define 5 Ncm or 10 Ncm boost value when **5** or **10** is displayed.

Settings reset

FIG. 4

K. Short press on the knob to display factory settings reset screen.

↳ The factory settings reset screen is displayed.

L. Turn the knob CW or CCW to alternatively display the **reset yes** or **reset no** text (1).

Note 4

M. Short press on the knob to restore factory settings when the **reset yes** text is displayed, or short press to go back to the Settings mode when the **reset no** text is displayed.

↳ Reset can take up to 2 seconds. Meanwhile, the  symbol is displayed, and the **yes** text is turned off. When reset is done, the Settings mode is displayed again.

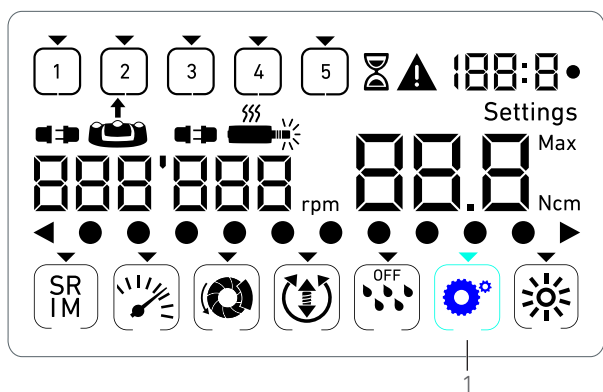

FIG. 3

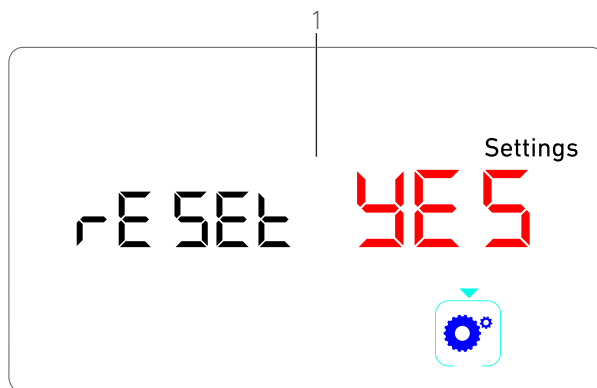







FIG. 4

NOTES

- 1 Pressing the footpedal has no effect in the Special modes.
- 2 Go through all the special modes to display the Settings mode again.
- 3 Reverse torque boost value is only available in Implantology mode when torquemeter is displayed (i.e. with speeds below 100 rpm).
- 4 The **reset no** text is displayed by default.

11 List of errors & Troubleshooting

11.1 Safety warning (operating)

Warning description	Message	Cause of warning	Action
Motor overheating		Excessive power demand of the MX-i LED micromotor.	Avoid extended use. Let system cool down.
Release pedal		<ul style="list-style-type: none"> Pedal is pressed when accessing settings sub-modes. Pedal is pressed during device startup. Pedal is pressed after recovering from an error. 	<ul style="list-style-type: none"> Confirm setting by pressing the knob. Release footpedal and press it again. Release footpedal and press it again.
Low to high speed step transition	 Speedometer blinking.	User switches from low speed to high speed (≥ 100 RPM) step in Implantology mode.	No action needed, the warning disappears after 2 seconds.
Motor jammed		Motor is jammed for more than 2 seconds. Motor power supply is cut to avoid overheating.	Release footpedal, release the bur and press footpedal again.
Footpedal not connected		Pedal is not connected to device.	Connect pedal to the device.
Motor not connected		Motor is not properly connected to device, Motor hardware is damaged.	<ol style="list-style-type: none"> Acknowledge error. (Re)connect the motor cable. Press on the rotating knob. If problem persists, contact Bien-Air Dental SA.

11.2 Device operating error

Error description	Cause of error	When	Action
ERROR 1			
Motor short-circuit	Electrical failure: short-circuit between motor phases.	In running mode.	Replace motor and/or cable.
ERROR 2			
Main controller error	Other fault condition detected by software.	Any time.	1. Switch off system. 2. Contact Bien-Air Dental SA.
ERROR 3			
Motor driver communication timeout error	Failure of DMX controller. Failure of main controller RS-232.	In running mode.	1. Switch off system. 2. Contact Bien-Air Dental SA.
ERROR 4			
Invalid EEPROM memory	Failure of EEPROM memory.	Any time.	Contact Bien-Air Dental SA. Acknowledging this error allows the operator to work normally but it will not allow settings to be saved or restored. This error will appear at each save or restoration attempt.
ERROR 5			
Motor drive over temperature	Motor overload in a high temperature environment. Failure of DMX controller.	Any time.	1. Wait for system cooling. 2. If problem persists, contact Bien-Air Dental SA.
ERROR 6			
Motor driver under voltage error	Motor overload in a high temperature environment. Failure of power supply.	Any time.	1. Acknowledge error. 2. If problem persists, contact Bien-Air Dental SA.
ERROR 7			
Motor driver over voltage error	Failure of power supply. Tool used has a too high inertia.	Any time.	1. Acknowledge error. 2. If problem persists, contact Bien-Air Dental SA.
ERROR 8			
Irrigation pump general failure	Electrical failure: short-circuit to ground or to supply. Electrical failure: short-circuit between motor phases.	In running mode.	1. Switch off sytem. 2. Contact Bien-Air Dental SA.
ERROR 9			
Knob failure	Electrical failure of knob encoder.	Any time.	1. Switch off sytem. 2. Contact Bien-Air Dental SA.

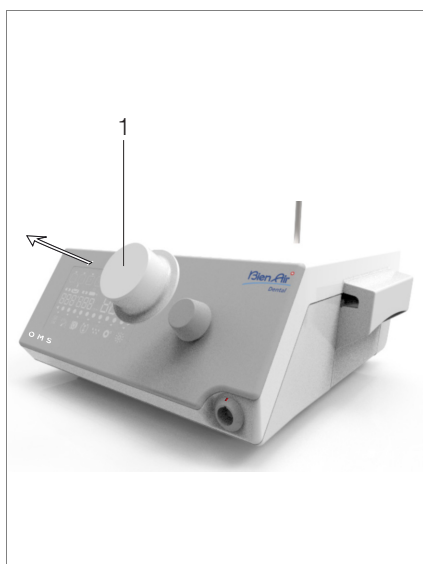

FIG. 1

12 Maintenance

⚠ CAUTION

Only use original Bien-Air Dental maintenance products and parts or those recommended by Bien-Air Dental. Using other products or parts may cause operational failure and/or void the guarantee.

12.1 Servicing

Never disassemble the device. For any modification and repair, we recommend that you contact your regular supplier or Bien-Air Dental SA directly.

Note 1

12.2 Cleaning & disinfection

FIG. 1

- Disinfect the surfaces of the OMS unit and footpedal by gently rubbing with a clean cloth soaked in a suitable product (i.e. Bien-Air Dental Spraynet or isopropyl alcohol for about 15 sec.).
- Remove the knob (1) and sterilize it a class B autoclave at 135°C.

Note 2

- Do not immerse in disinfectant solution.
- Not designed for an ultrasonic bath.
- Use a new sterile irrigation line for each patient.
- Use a new sterile protective sheet for each patient.

12.3 Important

For maintenance: See instructions for use

MX-i LED micromotor..... REF 2100245

Cable for micromotor..... REF 2100163

Contra-angle CA 20:1 L, light..... REF 2100209

Contra-angle CA 20:1 L

Micro-Series, light..... REF 2100209

Contra-angle CA 20:1 L KM, light..... REF 2100209

Contra-angle CA 20:1 L KM

Micro-Series, light..... REF 2100209

Contra-angle handpiece EVO.15 1:5 L

Micro-Series, light..... REF 2100294

Contra-angle handpiece EVO.15 1:5 L,

light..... REF 2100294

Contra-angle handpiece CA 1:5 L

Micro-Series, light..... REF 2100294

Contra-angle handpiece CA 1:5 L,

light..... REF 2100294

Contra-angle handpiece CA 1:5..... REF 2100294

Contra-angle handpiece CA 1:2.5 L

Micro-Series, light..... REF 2100337

Straight Handpiece 1:1 REF 2100046

Straight Handpiece 1:2 REF 2100103

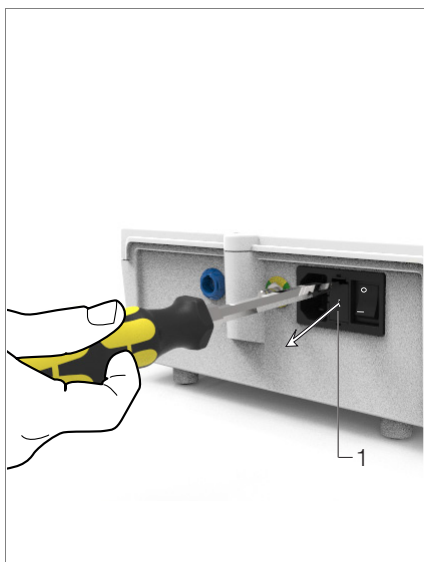

FIG. 2

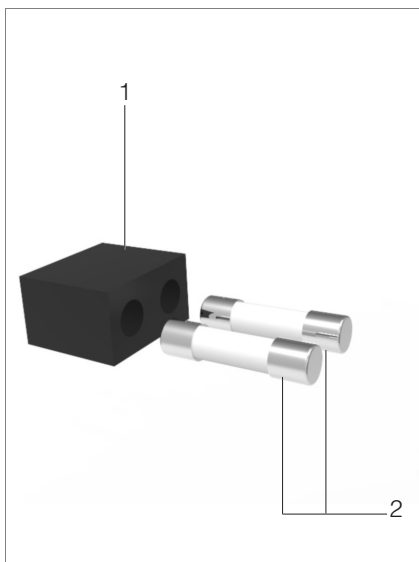

FIG. 3

12.4 Replacement of fuses

- A. Switch off the OMS unit.
- B. Disconnect the mains cable.

⚠ CAUTION

The power cable must be disconnected at least 10 seconds before opening the fusebox.

FIG. 2

- C. Remove the fuse box (1) with a flat screwdriver.

FIG. 3

- D. Replace the fuses (2) by the new ones and put the fuse box back (1) in place.

⚠ CAUTION

Only use fuses T4.0AH 250 VAC REF 1307312-010.

NOTES

- 1 Bien-Air Dental SA recommends the user to have its dynamic instruments regularly checked or inspected.
- 2 The knob is hold magnetically. There is no need to preserve its angular position when removing it or putting it back in place.

13 General information and guarantee

13.1 General information

The device must be used by qualified professionals in compliance with the current legal provisions concerning occupational safety, health and accident prevention measures, and these instructions for use. In accordance with such requirements, the operators:

- must only use devices that are in perfect working order; in the event of irregular functioning, excessive vibration, abnormal heating or other signs that may indicate malfunction of the device, the work must be stopped immediately; in this case, contact a repair center that is approved by Bien-Air Dental SA;
- must ensure that the device is used only for the purpose for which it is intended, must protect themselves, their patients and third parties from any danger.

13.2 Terms of guarantee

Bien-Air Dental SA grants the user a guarantee covering all functional defects, material or production faults.

The device is covered by this guarantee from the date of invoicing for:

- 12 months for the hose;
- 24 months for the OMS unit and CA 20:1 L Micro-Series;
- 36 months for the MX-i LED micromotor.

In case of justified claim, Bien-Air Dental SA or its authorized representative will fulfill the company's obligations under this guarantee by repairing or replacing the product free of charge.

Any other claims, of whatever nature, in particular in the form of a claim for damages and interest, are excluded.

Bien-Air Dental SA shall not be held responsible for damage or injury and the consequences thereof, resulting from:

- excessive wear and tear
- improper use
- non-observance of the instructions for installation, operation and maintenance
- unusual chemical, electrical or electrolytic influences
- poor connections, whether of the air, water or electricity supply.

The guarantee does not cover flexible "fiber optic" type light conductors, or any parts made of synthetic materials.

The guarantee shall become null and void if the damage and its consequences are due to improper manipulation of the product, or modifications to the product carried out by persons not authorized by Bien-Air Dental SA.

Claims under the terms of the guarantee will be considered only on presentation, together with the product, of the invoice or the consignment note, on which the date of purchase, the product reference and the serial no. should be clearly indicated.

Please refer to the General Terms and Conditions of Sale on www.bienair.com.

 **Bien-Air Dental SA**

Länggasse 60 Case postale 2500 Bienne 6 Switzerland

Tel. +41 (0)32 344 64 64 Fax +41 (0)32 344 64 91

dental@bienair.com

Other addresses available at

www.bienair.com