

# Aquilon

 Do not sterilize



ENG Instructions for use

Other languages available on <https://dental.bienair.com/ifu>



RX Only

2100033-0004 /2024.05

Devices	
	
MOT AQUILON830 SR	MOT AQUILON830 IR NC
REF 1600362-001	REF 1600070-001



















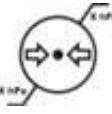

Optional accessories	
	
REF 1600081-001	REF 1600082-001
	
3-hole	4-hole
REF 1600242-001	REF 1600243-001
	
REF 1600036-006	REF 1600064-006
	
REF 1600967-010	

# Table of contents

1 Symbols	3
1.1 Description of symbols used	3
2 Identification & Intended Use	4
2.1 Identification	4
2.2 Classification	4
2.3 Intended Use	4
3 Warnings and Precautions for use	5
4 Identification & Intended Use	6
4.1 Overview	6
4.2 Technical Data	7
5 Cleaning and Servicing	8
5.1 Maintenance - General information	8
5.2 Cleaning	8
5.3 Disinfection	8
5.4 Lubrication	9
5.5 Packing and storage	9
5.6 Servicing	9
6 Transport and Disposal	10
6.1 Transport & Disposal	10
6.2 Disposal	10
7 General Information	11
7.1 Terms of guarantee	11
7.2 References	11

# 1 Symbols

## 1.1 Description of symbols used

Symbol	Description	Symbol	Description
	CE Marking with number of the notified body.		Manufacturer.
	WARNING! hazard that could result in serious injury or damage to the device if the safety instructions are not correctly followed.		Operator's manual; operating instructions.
	CAUTION! hazard that could result in light or moderate injury or damage to the device if the safety instructions are not correctly followed.		Data Matrix code for product information including UDI (Unique Device Identification).
	Move in the direction indicated.		Move fully to the stop, in the direction indicated.
	3-hole connection.		4-hole connection.
	Temperature limitation.		Humidity limitation.
	Atmospheric pressure limitation.		Medical device.
	Keep away from rain.		Serial number.
	Wear rubber gloves.		Catalogue number.
	Lamp, lighting, illumination.		Batch code.
Rx Only	Warning: in accordance with federal law (USA), this device is only available for sale upon recommendation by an accredited practitioner.		General symbol for recovery/recyclable.

## 2 Identification & Intended Use

### 2.1 Identification

Medical devices manufactured by Bien-Air Dental SA.

#### Type

Dental air motors, without light, non-sterilizable.

#### Description

Air motors intended to generate a rotating mechanical energy from the compressed air supplied by the dental unit. They can be connected to dental straight or contra-angle handpieces using the Unifix couplings.

Ref	Device name	Spray	Light
1600070-001	AQUILON 830 IR NC	Internal Spray	Without light (as per ISO Standard 3964).
1600362-001	AQUILON 830 SR	External Spray	Without light (as per ISO Standard 3964).

### 2.2 Classification

Class IIa according to European Directive 93/42/EEC relating to medical devices. Those medical devices comply with the legislation in force.



#### WARNING

Any use other than that for which this device is intended is prohibited and may prove dangerous.

### 2.3 Intended Use

Product intended for use in general dentistry.

#### Intended User

Bien-Air Dental SA's air motors are intended for professional use: they are meant to be used by qualified dental staff only.

## 3 Warnings and Precautions for use

Those medical devices must be used by professionals in compliance with the legal provisions in force regarding occupational safety, health and accident prevention measures, and these instructions for use.

In accordance with these provisions, the user is responsible for ensuring he or she only uses devices which are in perfect working order.

In the event of irregular operation, excessive vibrations, abnormal heating, unusual noise or other signs suggesting that the device is malfunctioning, work must be suspended immediately.

In this case, contact a repair centre approved by Bien-Air Dental SA.

### WARNING

Medical personnel using or performing maintenance on medical devices that are contaminated or potentially contaminated must comply with universal precautions, in particular the wearing of personal protective equipment (gloves, goggles, etc.). Pointed and sharp instruments should be handled with great care.

### WARNING

Never insert or remove a device while the motor is rotating.

### CAUTION

If any serious incident occurs in relation to the device, report it to a competent authority of your country, as well as the manufacturer through your regional distributor. Observe relevant national regulations for detailed procedures.

### CAUTION

It is essential to use dry, purified compressed air in order to ensure the long working life of the device. Maintain the quality of the air and the water by regular maintenance of the compressor and the filtration systems. The use of unfiltered hard water will lead to early blockage of the tubes, connectors and spray cones.

### WARNING

Rest the device on a suitable support to avoid risks of infection for yourself, the patient or third parties.

Note: the technical specifications, illustrations and dimensions contained in these instructions are given merely as an indication. They may not give rise to any claim.

For any further information, please contact Bien-Air Dental SA at the address given on the back cover.



FIG 1

## 4 Identification & Intended Use

### 4.1 Overview

- 1) Spray tube
- 2) Motor nose
- 3) Motor sleeve

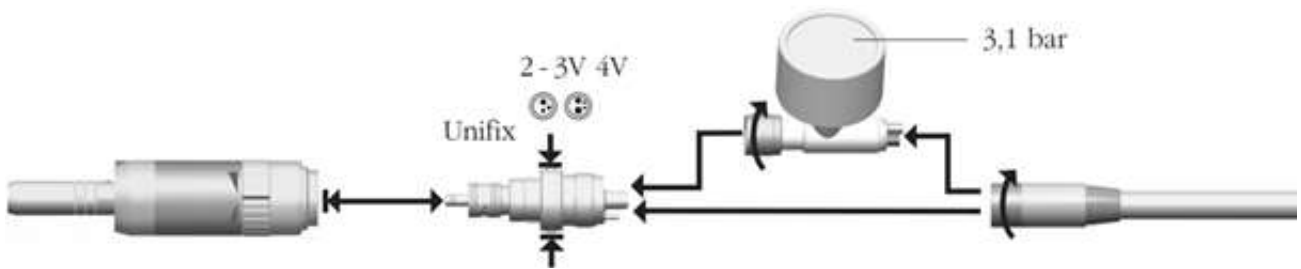

FIG 2

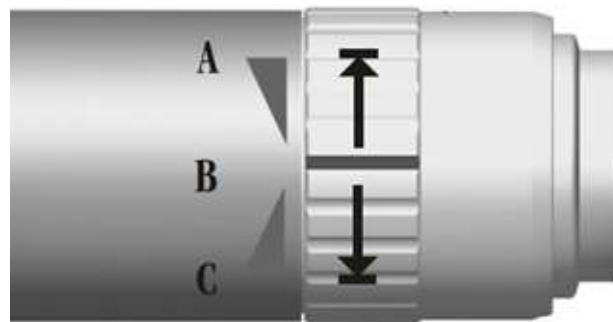

FIG 3



FIG 4

Changing the seals

## 4.2 Technical Data

1600070-001	AQUILON 830 IR NC		
		Spray	Internal spray
		Light	Without light (as per ISO Standard 3964).
		Dimension	Ø 22 x 91 mm.
		Weight	90 g without the cable.
		Coupling	Compatible with 2-3 or 4 way connection through Unifix coupling (FIG 2)
		Rotation	Clockwise & counter-clockwise; position A, B and C (FIG 3)
		Air consumption output	63 NI/min
		Recommended rotation speed	from 3'000 to 20'000 rpm
		Mechanical power	32 W
		Torque	46 mNm
		Noise level	In accordance with ISO 14457, less than 64 dBA at 45 cm
		Required air pressure	Adjust the required air pressure to 3.1 bar with the assistance of a Bien-Air Dental inspection pressure gauge - 3-hole version or 4-hole version, placed between hose and Unifix coupling (FIG 2).
		Spray water flow at 250 kPa	159 ml/min
		Spray air flow at 250 kPa	7.1 NI/min

1600362-001	AQUILON 830 SR		
		Spray	External spray
		Light	Without light (as per ISO Standard 3964).
		Dimension	Ø 22 x 91 mm.
		Weight	90 g without the cable.
		Coupling	Compatible with 2-3 or 4 way connection through Unifix coupling (FIG 2)
		Rotation	Clockwise & counter-clockwise; position A, B and C (FIG 3)
		Air consumption output	62 NI/min
		Recommended rotation speed	from 3'000 to 20'000 rpm
		Mechanical power	32 W
		Torque	46 mNm
		Noise level	In accordance with ISO 14457, less than 64 dBA at 45 cm
		Required air pressure	Adjust the required air pressure to 3.1 bar with the assistance of a Bien-Air Dental inspection pressure gauge - 3-hole version or 4-hole version, placed between hose and Unifix coupling (FIG 2).
		Spray water flow at 250 kPa	214 ml/min
		Spray air flow at 250 kPa	9.5 NI/min





FIG 5

## 5 Cleaning and Servicing

### 5.1 Maintenance - General information

#### WARNING

Non sterilizable

#### 5.1.1 Precautions for maintenance

- Clean and lubricate the device before the treatment of each patient.
- Only use original Bien-Air Dental SA maintenance products and parts or those recommended by Bien-Air Dental SA.

#### CAUTION

- Use detergents that are pH 8-11, are neither corrosive nor contain chlorine or acetone and/or aldehydes.
- Do not submerge in physiological liquid (NaCl) nor use saline solution to keep the device moist until it can be cleaned.
- Never immerse in disinfectant solutions
- Not suitable for ultrasonic bath
- Not suited for thermo-washer disinfectors.

#### 5.1.2 Suitable maintenance products

Manual cleaning:

- Spraynet

Manual disinfection:

- Alkaline detergent or detergent disinfectant (pH 8-11) recommended for cleaning-disinfection of dental or surgical instruments. Disinfectant products composed either of didecyldimethylammonium chloride, quaternary ammonium carbonate or neutral enzymatic product. (e.g. Neodisher® mediclean) are also allowable.

### 5.2 Cleaning

Carefully clean all the surfaces with a cloth impregnated with Spraynet, (FIG 5).

### 5.3 Disinfection

Disinfect the device with a clean cloth soaked in a suitable product.



FIG 6

## 5.4 Lubrication

Lubricate at least twice a day. Only use the spray Lubrifluid.

- Place the device in a cloth so as to catch the debris and foreign matter expelled by the atomizer jet.
- Insert the nozzle into the back of the instrument sleeve. Spray for about 1 second (FIG 6).





## ⚠ CAUTION

If the medical device has been stored refrigerated, allow it to warm up to room temperature prior to its use.

## 5.6 Servicing





Bien-Air Dental SA recommends that the user has his or her dynamic devices checked or serviced every three years.

## 5.5 Packing and storage

Storage		
	Temperature range:	0°C / +40°C
	Relative humidity range:	10% - 80%
	Air pressure range:	650 hPa - 1060 hPa
	Keep away from rain	

# 6 Transport and Disposal

## 6.1 Transport & Disposal

Transport		
	Temperature range:	-20°C / +50°C
	Relative humidity range:	10% - 80%
	Air pressure range:	650 hPa - 1060 hPa
	Keep away from rain	

## 6.2 Disposal



The disposal of this device must be performed in accordance with the legislation in force.

# 7 General Information

## 7.1 Terms of guarantee

Bien-Air Dental SA grants the user a warranty covering any operating fault, or material or manufacturing defect.

The warranty period is:

- 12 months for the Aquilon micro-motors

In the event of a justified claim, Bien-Air Dental SA or its authorized representative will repair or replace the product free of charge.

All other claims of any kind whatsoever, particularly claims for damages, are excluded.

Bien-Air Dental SA cannot be held liable for damage or injury and the consequences thereof, resulting from:

- Excessive wear and tear
- Infrequent or improper use
- Failure to observe the servicing, assembly or maintenance instructions
- Damage caused by unusual chemical, electrical or electrolytic influences
- Faulty air, water or electrical connections.



### CAUTION

The warranty becomes null and void if damage and its consequences result from incorrect servicing or modification by third parties not authorized by Bien-Air Dental SA. Warranty requests will only be taken into consideration if the product is accompanied by a copy of the invoice or delivery note. The following information must be clearly indicated: purchase date, product reference and serial number.

## 7.2 References

REF	LEGEND
1600070-001	MOT AQUILON830 IR NC with internal spray, without light, with 2-3 and 4-hole Unifix rotating quick coupling
1600362-001	MOT AQUILON830 SR with external spray, without light, with 2-3 and 4-hole Unifix rotating quick coupling
1600081-001	Unifix 2-3-hole coupling
1600082-001	Unifix 4-hole coupling
1600242-001	Gauge for 3-hole attachment
1600243-001	Gauge for 4-hole attachment
1300967-010	O-RING 8.1x0.73
1600036-006	Spraynet, cleaning spray 500 ml, box of 6 cans
1600064-006	Lubrifiuid, lubricant 500 ml, box of 6 cans



Bien-Air Dental SA  
Länggasse 60 Case postale 2500  
Bienne 6 Switzerland  
Tel. +41(0)323446464 Fax +41(0)323446491  
dental@bienair.com  
Other addresses available at  
[www.bienair.com](http://www.bienair.com)



Bien-Air Europe Sàrl  
19-21 rue du 8 mai 1945  
94110 Arcueil  
France